

Diese Zeichnung ist unser geistiges Eigentum und darf ohne unsere Ermächtigung weder kopiert, vervielfältigt noch Dritten oder Konkurrenzfirmen zugänglich gemacht werden. (Art. 12 B.G.)
 This drawing is copyright. Information contained thereon is supplied in confidence and must not be used for any other purpose than which it was supplied, or be reproduced without written permission of the owners.

Cable shortening dimension

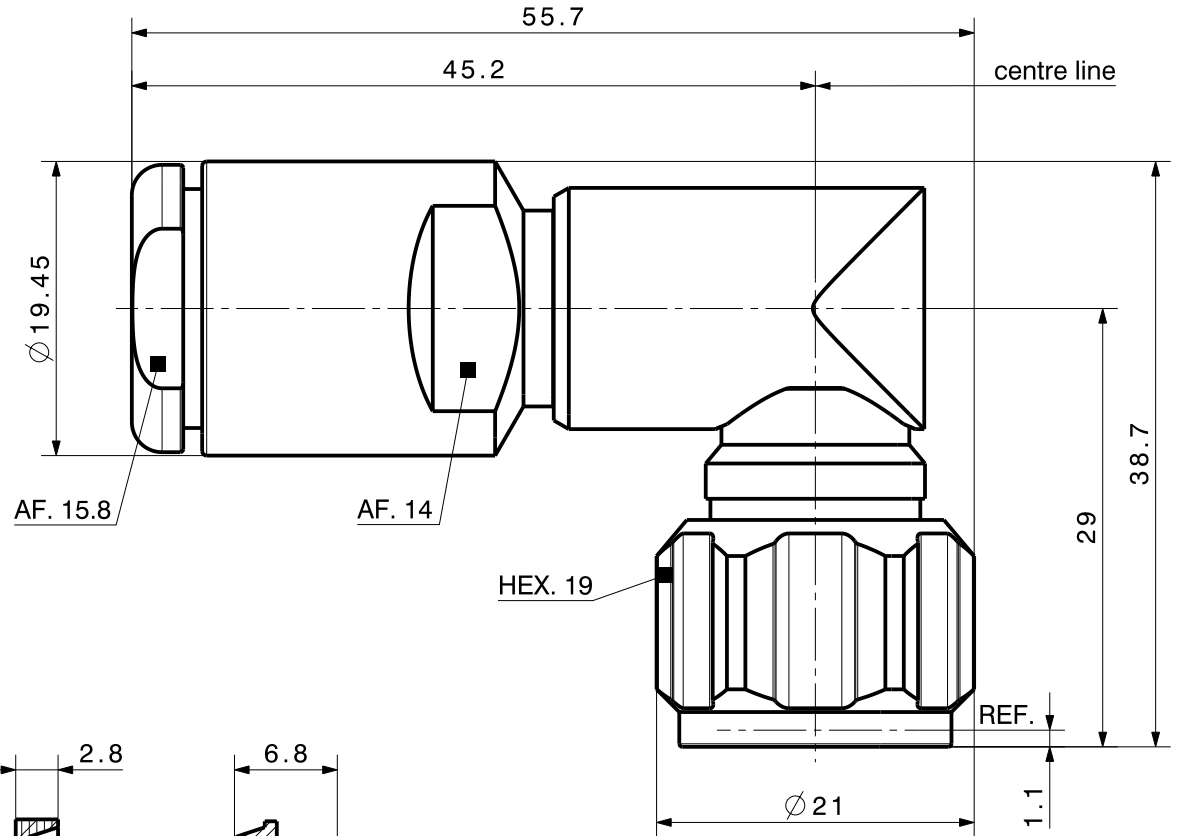

type / Typ: 16_N-50-7-50	
⊕ dimensions in millimeter [mm]	part no. / Teile Nr.: PRO-00101519 B sheet/Blatt XX / XX
description / Beschreibung	drawing-no. / Zeichnungsnr. Release
Right angle cable plug	DOU-00101519 B

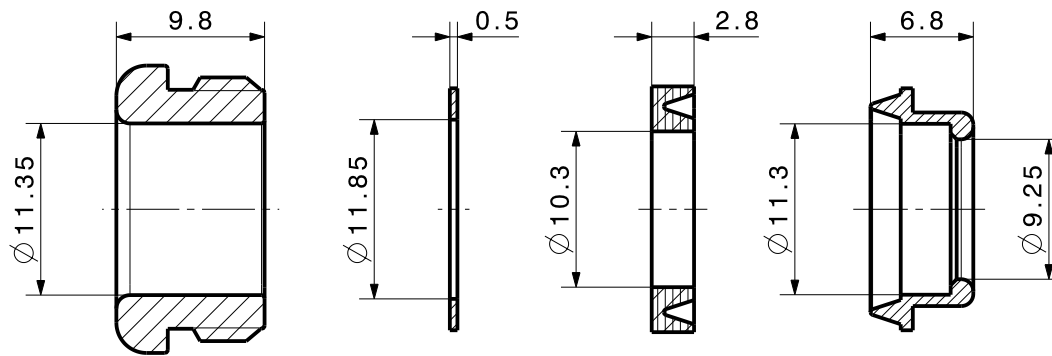
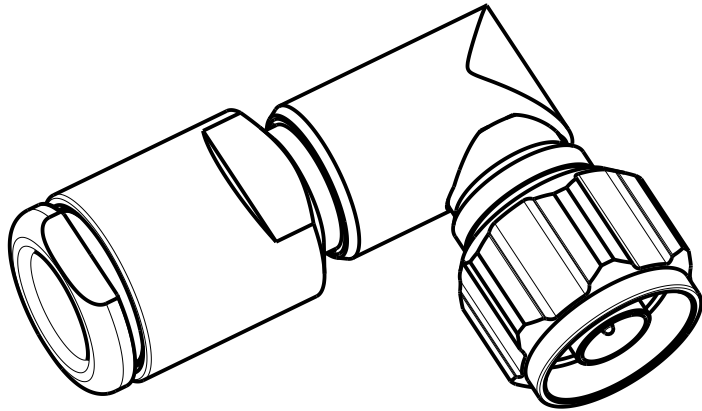
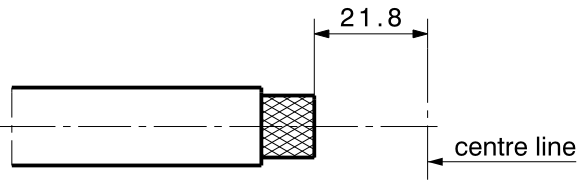

alternative ID: