

High Bay Ufo

150W LED High Bay Specification



Parameters

Product Model	HBUE-150W-120D-ONOFF
LED Chip Brand	Seoul
Light Efficiency	160lm/W (140 lm/W optional)
Luminous Flux	24000 lm
Color Temperature	5000K(3000K, 4000K optional)
Beam Angle	90° (60°, 120°optional)
Total Power Consumption	150W±8W
Output Current	1.18A(constant current)
Output Voltage	DC 116 ~ 124V
Net Weight	3.6±0.2kg
Light Dimensions	L300mm×W300mm×H191mm
Light Package Dimensions	L350mm×W350mm×H230mm

Light Distribution

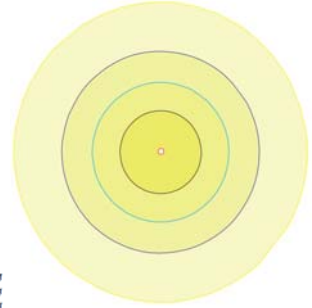
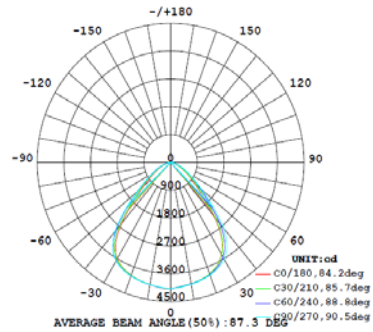

Physical Dimensions

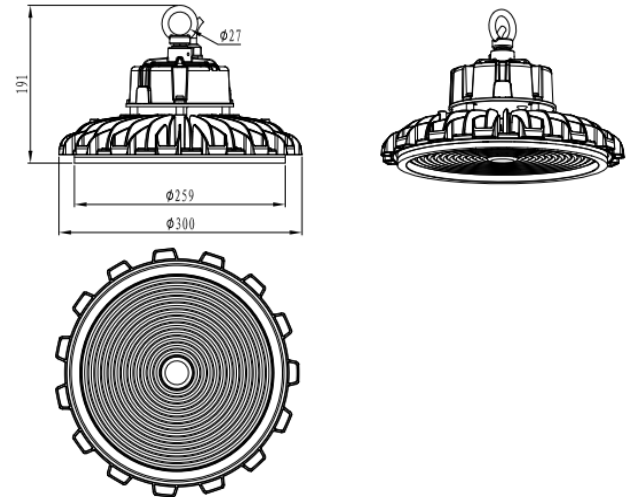

≥0.95	70 Ra	IP65	≥100000 Hrs	AC 100-277V	47-63Hz
Power Factor	CRI	IP Level	TM-21(L ₇₀)	Input Voltage	Power Frequency

Others

Power Efficiency	Working Temperature (Environment)	Heat Sink Surface Temperature
≥94%	-40°C ~ +50°C	67.3°C(Room Temperature 30°C)
Fixture Efficiency	Working Humidity (Environment)	Luminaire Base Temperature
≥90%	15% ~ 90%RH	74.1°C(Room Temperature 30°C)
Total Harmonic Distortion	Storing Condition	LED Power Consumption
≤15%	-40°C ~ +65°C	141W±6W

Suitable for Factory, Warehouse, Gymnasium, Gas station, Shopping mall, Garage and other Lighting Purposes