



## Safe Operation & Maintenance Instructions

**NEMIQ**<sup>™</sup>  
The smart choice

# Rechargeable Cable Cutter

**NBCC-50**



**Version: 2020/06**

**Professional Rechargeable Cable Cutters** are carefully inspected for quality and tested for safety. We follow ISO 9001: 2015/ ISO 14001: 2015/ IECQ QC 080001/ ISO45001:2018 & UVDB

### ***ATTENTION!***

*Safe Operation & Maintenance Instructions must be followed.*

Thank you for using **our** products. This manual must be read carefully prior to operating this product. Special attention should be paid to the section "Safety Instructions". Damages and injuries caused by improper use of this product are **NOT** included in our warranty. We would like to remind you to work safely and to keep this manual on hand.

## Safety Instructions

- Follow ALL instructions to ensure safety.

<b>WARNING</b>	
	This product is <b>NOT</b> an insulator and cannot be used near energized conductors.
	Do not use this tool on glass, plastic, wood or any other materials which could shatter. <b>Do not exceed equipment ratings.</b>
<b>ATTENTION</b>	
	Always wear safety goggles when operating this product. Projectiles or hydraulic fluid can cause serious injuries.
	Read all instructions, warnings, and cautions carefully. Follow all safety precautions to avoid personal injury or property damage.

# Table of Contents

■ Safety Instructions.....	1
■ Table of Contents.....	2
■ Safety Instructions.....	3
■ Product Description.....	4
■ Operating Instructions.....	5
■ Guide Piece Replacement / Blade Replacement.....	7
■ Maintenance.....	9
■ Trouble Shooting.....	10
■ Limited Lifetime Warranty.....	11
■ Table of Components.....	13
■ Diagram of Components.....	14
■ Manufacture & Quality Certificate	

# Safety Instructions

## Work Area Safety

1. Keep the area around the tool clean and free of obstructions.
2. Keep the area free of flammables which could ignite while using this tool.
3. Children and bystanders should stay clear of the work area to ensure safety

## Electrical Safety

1. Use only the specified battery charger for the battery.
2. Use only the designated battery pack with this tool.
3. Do not modify the charger in any way. Ensure the charger matches the electrical outlet.
4. Avoid electrical shock. Do not touch grounded metal conductors while operating this tool.
5. Do not use this tool in wet conditions. Store this tool in a dry place.
6. Do not drop or in any way abuse or disassemble the battery pack or charger.

## Personal Safety

1. Stay alert while using this tool to prevent serious injury. Do not use under the influence of drugs, alcohol or medicine.
2. Do not wear loose hair or clothes that can get caught in the tool while operating.
3. To reduce the risk of injury, wear non-conductive gloves and non-skid safety-shoes. Always wear protective eyewear.
4. Make sure the tool switch is OFF or the tool locked before inserting the battery pack.
5. After servicing the tool, remove adjusting keys or wrenches from any moving parts of the tool before use.
6. Work safely. Maintain your balance and do not reach while operating the tool.

# Product Description: NBCC-50

## ■ Specifications:

Height: 317mm (H)  
 Weight: 2.2 kg (w/o battery)  
 Drive unit: 18V DC Motor  
 Charger (GS/CE):

Input voltage: **NBCC 50-120**  
 110V Single Phase AC Input  
 voltage: **NBCC 50-230** 230V  
 Single Phase AC Input  
 frequency: 50-60Hz Input  
 current: 21.75 VA

## ■ Accessories:

- Plastic carrying case
- 18V Li-ion Battery, 110V or 230V Charger

## ■ Cutting Capacity: (Max. Cable diameter)

- Nonferrous 50mm

Model No.	Specification
	600V-CV325 mm <sup>2</sup> (31 mm OD)
Polyethylene cable	600V-CV150 mm <sup>2</sup> x 3(46 mm OD)
	600V-CV500 mm <sup>2</sup> (38 mm OD)
	6KV-CVT500 mm <sup>2</sup> (45 mm OD)
Multi-core vinyl insulation cable	VVR150 mm <sup>2</sup> (47 mm OD) 3 core
Soft copper cable	IV500 mm <sup>2</sup> (35 mm OD)
Hard copper cable	150 mm <sup>2</sup> (21 mm OD)

## Battery Specifications



**Brand:** BOSCH  
**Type:** lithium-ion (Li-ion)  
**Capacity:** 4.0 Ah  
**Output Voltage:** 18V  
**Input Frequency:** 50-60 Hz

## Charger Specifications



**Model No.:** AL 1860 CV  
**Input Voltage:** 110V / 230V  
**Charging per battery:** Approx. 30min <3.0Ah>



# Operating Instructions

1. Install the charged battery by sliding it into the base of the tool handle until it clicks into place. The battery should be secured and unmoveable.



2. Take a look at the operation of tool switch system. There are 3 settings: Move to left (Forward), Middle (Neutral), Move to right (Reverse). When the tool is not in use or is idle, it should rest in the central position. Now the Picture it shows the cutter stay in Neutral.

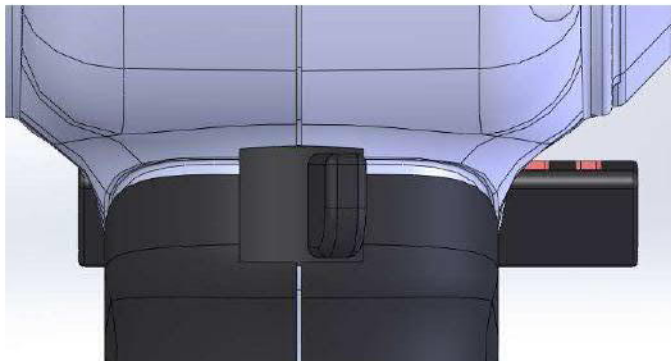
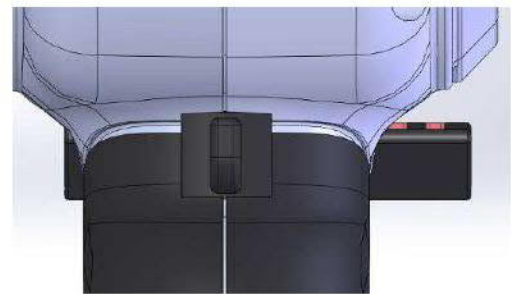

**When the switch to the right, the blade goes backward.**

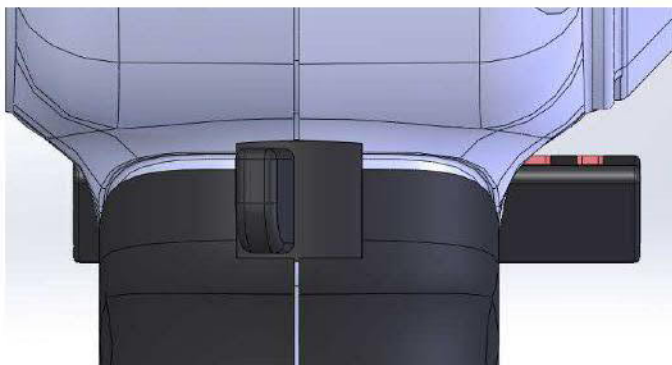
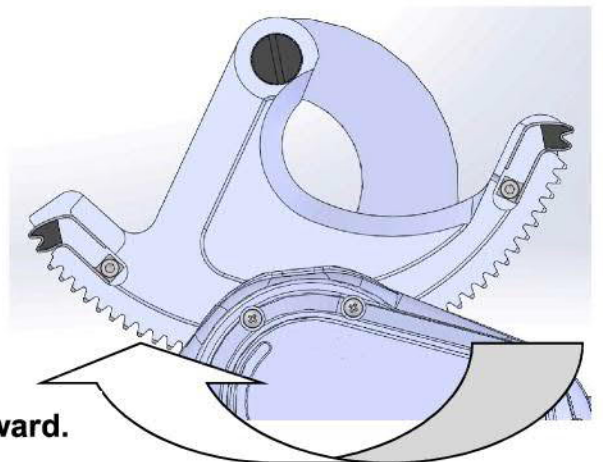

**When the switch to the left, the blade goes**

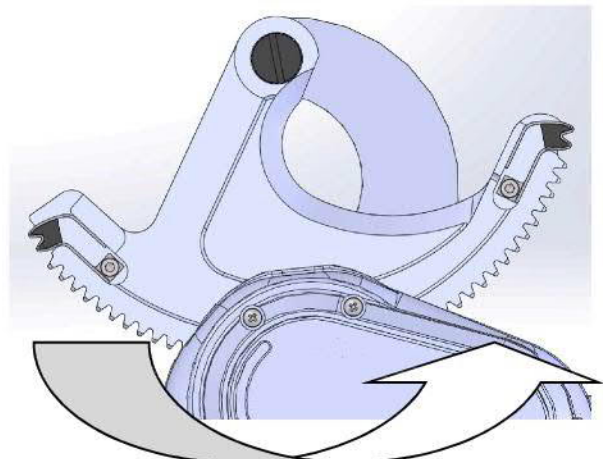

3. Please find below diagram regarding on the safety switch.

The safty switch need to be press in the same time when you press the trigger to make the blade moving, once the blade move, then the finger press on the safety switch can be remove.

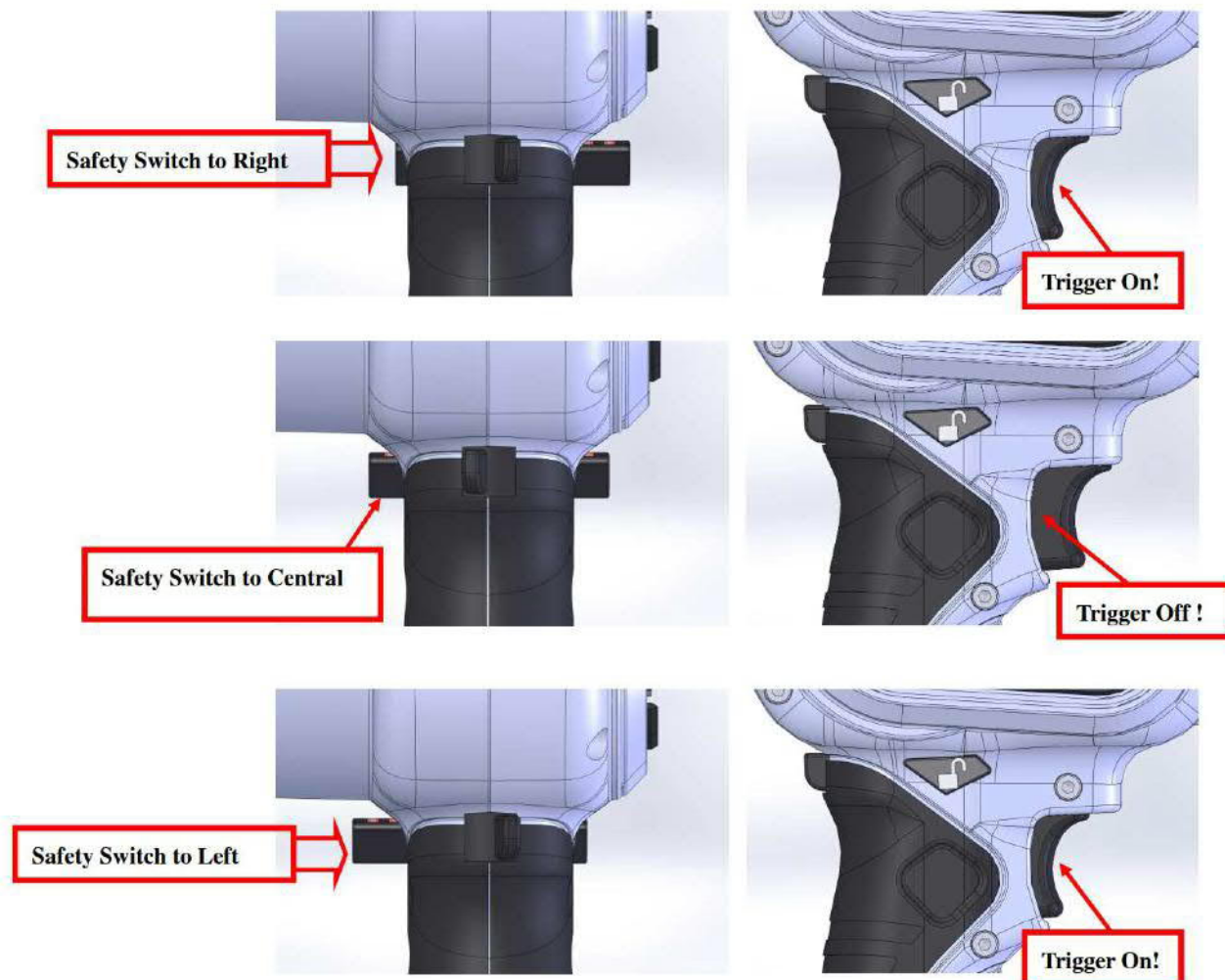

4. When the tool is sitting idly or once you are finished with it, put the tool switch in the central position.

<b>ATTENTION</b>	
	<b>Keep your fingers away from edge of the moving blade when feeding it into the gear mechanism. The switch may have moved from the NEUTRAL position.</b>

# Guide Piece Replacement

1. Operate the cutter either forwards or backwards until the moving blade disengages from the pinion gear and can be pulled free.
2. Remove the battery from the cutter.
3. Use a M2.5-sized Allen wrench to loosen and remove the screw which secures the gear guide to the moving blade. Install the replacement guide and tighten the screw. Repeat to replace the second gear guide.
4. Reinstall the battery pack. Feed the the moving blade into the gear mechanism. Test the new blade movement. If necessary, repeat the procedure from Step 1.

# Battery Charging

1. After removing the battery from the power tool, insert it into the battery charger. The red indicator will light up and indicate the battery is charging.
2. The green light comes on after approx. 30 mins when the battery is fully charged.
3. Remove the battery from the charger and install into the handle of the power tool sliding it into the base of the tool handle until it clicks into place. The battery should be secured and unmoveable.
4. The charger will not operate effectively if overheated. Allow 10 minutes to cool down between charges if charging consecutive batteries.

<b>ATTENTION</b>	
	<p><b>DO NOT dispose of this battery in a fire or otherwise abuse the battery.</b></p> <p><b>DO NOT short circuit battery output terminals</b></p> <p><b>DO NOT disassemble or modify the battery. This may lead to short circuiting the battery cells causing personal injury or damage to the battery.</b></p> <p><b>Keep your fingers away from edge of the moving blade when feeding it into the gear mechanism. The switch may have moved from the NEUTRAL position.</b></p>



# Blade Replacement

1. Operate the cutter forwards or backwards until the moving blade disengages from the pinion gear and can be pulled free.
2. Remove the battery from the cutter.
3. Secure the lock nut with a wrench and loosen the shoulder screw with a flat screwdriver. Remove the moveable blade from the tool and collect the two curved washers.
4. Use a M2.5-sized Allen wrench to loosen and remove the two screws which secures each of the orange gear guides to the moveable blade. Install the gear guides on the new blade. Screw them into place firmly, with the lock-washer between the screw head and the gear guide.
5. Install the new moving blade and assemble the shoulder screw. Position the two curved washers between the shoulder screw head and moving blade. Hold the lock nut with the wrench and tighten the shoulder screw.
6. Reinstall the battery pack. Feed the the moving blade into the gear mechanism. Test the new blade movement. If necessary, repeat the procedure from Step 1.

# Maintenance

- After use, look for burrs or dents in the blade. If burrs exist they can be removed with a flat grinding stone. Clean, sharp blades will provide better and safer performance and put less strain on the tool.
- The plastic housing can be kept clean with a soft soap cloth. Use a lubricant to clean the blades if necessary.
- Keep the handle dry and free of grease at all times.
- Do NOT let the tool drop to the ground or into the carrying case to avoid damage to internal parts or to the plastic housing.
- Store in a cool, dry area. Do NOT keep this product in places with high temperatures, high humidity, or direct sunlight.
- Inform authorized distributors in case of any abnormalities or malfunctions of the product.
- **DO NOT DISASSEMBLE OR ATTEMPT TO REPAIR THIS TOOL.**  
Disassembly of this tool beyond changing the moving blade and gear guides will void the warranty.

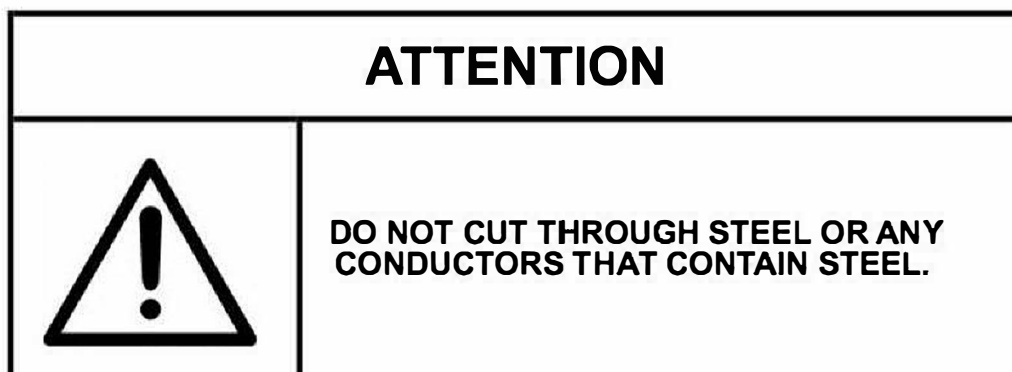

# Trouble - Shooting

## ■ The Cable cannot be cut:

- A. Tool Blades are worn or damaged. The blades must be replaced. Tools with worn or damaged blades might cause property damage or even personal injuries.
- B. Applied cable is over-specification. Please check the specification table. The circuit breaker will need to be reset.
- C. The blade might be deformed by uneven distribution after cutting an off-center cable.

## ■ Charging Lamp does not light up:

- A. Dust, etc. has entered the battery cartridge. Clean the battery to remove any obstructions.
- B. Battery cartridge is overheating. Allow the cartridge to cool before conditioning.

## ■ Even fully charged, the cutting capacity is reduced:

- A. Life of the battery has expired. Replace the battery cartridge with a new cartridge.
- B. Deterioration of the blade. Replace the blade with a new blade.

## ■ Tool does not operate:

- A. Battery cartridge is not charged. Charge the battery cartridge.
- B. The battery contacts are dirty. Clear the battery contacts of dirt or debris.
- C. The circuit breaker has been actuated. Push the reset pin to reset the circuit breaker back to its original position.
- D. The OFF lock is not fully depressed. Make sure it is fully depressed and reset the circuit breaker if necessary.

## Limited Lifetime Warranty

- Our electronic products are warrantied against defects in materials and workmanship for one year.
- This warranty is subject to the following exclusions and limitations:
  1. This warranty does not cover damages to products which are not installed, operated, used and maintained in accordance with written instructions.
  2. This warranty does not cover products that have been worn out, damaged by improper storage, damaged or otherwise altered, or from disassembly or attempted disassembly by parties other than **us** or its authorized service representatives.
  3. This warranty does not cover damages caused by the use of components not manufactured or authorized by **us**, acts of God, accidents, or use in a manner for which they are not intended.
- **Our's** liability in all cases is limited to, and shall not exceed, the purchase price paid. We shall not be liable to any buyer for consequential or incidental damages of any kind.
- Batteries, chargers, electric motors, gas engines and cutting blades sold with our products are not covered by this warranty. All electric motors and gas engines are seperately warrantied by the manufacturer.
- Receipt and warranty card are required for warranty services.
- If the tool is found to be defective, in our sole judgement, We will either repair or replace the defective product or part.
- All revisions in warranty policy and product informations will be included in future versions of our manuals. Copies of this warranty are available from the factory upon request.



- **Replace any worn or damaged parts immediately. Do not use parts not supplied by us.**
- **Contact our service representatives to request parts or for problems not shown above.**
- **Do NOT attempt to disassemble or repair the product.**
- **Our hydraulic tools must be serviced by a qualified technician. Contact your our representative for more information.**



## **ATTENTION!**

*Do not dispose of batteries or electrical appliances as unsorted municipal waste. Use separate collection facilities\*. If electrical appliances are disposed of in landfills or dumps, hazardous substances can leak into the groundwater and damage the public's health and well-being.*

*\*Contact your local government for information regarding the collection systems available.*

# Table of Components

No.	Parts	Q'ty	No.	Parts	Q'ty
1	MOTOR & GEAR BOX SET	1	18	TRIGGER	1
2	PIN	2	19	SWITCH	1
3	FIXED BLADE	1	20	SCREW	7
4	SPRING WASHER	11	21	BRUSH	1
5	SCREW	11	22	SCREW	2
6	BEARING	1	23	MOVING BLADE	1
7	GEAR	1	24	WASHER	1
8	BEARING	1	25	SCREW	1
9	GEAR BOX COVER	1	26	SPRING WASHER	1
10	COVER	1	27	NUT	1
11	SPRING WASHER	2	28	GEAR GUIDE LEFT	1
12	SCREW	2	29	SCREW	2
13	HOUSING	1	30	GEAR GUIDE RIGHT	1
14	PIN	1	31	COVER	1
15	CHAIN	1	32	COVER	1
16	PRINTED CIRCUIT BOARD	1	33	WASHER	1
17	COMPRESSION SPRING	1			

# Diagram of Components

# NBCC 50

